

Yearly  
report  
CCGEX

2017

Charging for  
the Future!



CCGEx at the Royal Institute of Technology (KTH) • [www.ccgex.kth.se](http://www.ccgex.kth.se)

Prepared by:  
Director Anders Christiansen Erlandsson  
Vice Director Mihai Mihaescu  
Vice Director Mats Åbom

## TABLE OF CONTENTS

<b>Summary</b> .....	<b>2</b>
<b>Introduction</b> .....	<b>3</b>
<b>Background</b> .....	<b>3</b>
<b>Long-term vision, mission and strategy</b> .....	<b>4</b>
<b>Organization</b> .....	<b>4</b>
<b>Measurable Outcomes</b> .....	<b>7</b>
<b>Overview on Research Activities 2017</b> .....	<b>8</b>
<b>Research Area: Compressor off-Design (CoD)</b> .....	<b>9</b>
<b>Research Area: HOTSIDE</b> .....	<b>10</b>
<b>Research Area: Exhaust After Treatment (EAT)</b> .....	<b>13</b>
<b>Research Area: Power Train System Integration (SYSINT)</b> .....	<b>14</b>
<b>Associated projects with CCGEx</b> .....	<b>16</b>
<b>Finances</b> .....	<b>17</b>
<b>Improvements during the year</b> .....	<b>19</b>
<b>Partners development</b> .....	<b>20</b>
<b>Outlook - CCGEx program period (2018-2022)</b> .....	<b>23</b>
<b>Posters</b> .....	<b>24</b>

## Summary

The Competence Center for Gas Exchange (CCGEx) has at the end of 2017 reached the final quarter of its third (3<sup>rd</sup>) period (2014-2017). Funding from the Swedish Energy Agency, KTH, Scania, Volvo Cars and Volvo GTT was agreed for the 2014-2017 period. The Center's third period of activity is a continuation of the operations in the three established research areas: "Cold Side: Compressor off Design - CoD", "HOTSIDE", and "Engine After Treatment - EAT". Moreover, a new area: "Power Train System Integration - SYSINT" was introduced during 2016 and was to be developed further in 2017.

All projects, PhD Students and research activities are organized within the four (4) mentioned research areas. The purpose with the Center's activities is to build a deeper knowledge of the gas exchange processes, and thereby lay the foundation for a future with more efficient gas exchange system. The research efforts are directed towards making the power train system more efficient and environment-friendly thus to increase fuel efficiency without losing performance and to lower emissions of hazardous substances whilst managing sound generation and attenuation in the engine gas handling system.

The area focus has increased the possibility for a joint academy and industry view regarding which issues are dealt with, and what the respective projects aim to answer and provide. The area focus has also facilitated for the industry and academy to jointly identify and provide "in-kind" contributions, which take the projects forward and provide possibilities that go far beyond those that the academy itself possesses.

When it comes to academic results, during 2017 the CCGEx published 15 peer-reviewed publications, among which 9 journal publications. Half of the CCGEx Doctoral students were in their finishing year, three (3) of them being in position to successfully defend their Doctoral thesis during 2017. Two (2) Licentiate theses were defended during 2017 and three Licentiate thesis seminars are scheduled for 2018. CCGEx has been represented at six (6) international conferences in 2017 (e.g. ASME-TurboExpo meeting, SAE World Congress 2017, The 6th International Conference on Jets, Wakes and Separated Flows (ICJWSF 2017), Cincinnati, USA). Four (4) MSc projects were carried out into connection with the Center during 2017.

During the course of the year, industry contributions have been added via e.g. Volvo GTT, BorgWarner in addition to the in-kind contributions from Scania and Volvo Cars. By the end of 2017, the program was essentially fully funded, with a positive outlook regarding future in-kind contributions from the industry.

During 2016-2017, intense work within the Center has been dedicated to finalize the program proposal for CCGEx phase IV. The program proposal was successfully formulated in close collaboration with industry/government, submitted and approved by the Department of Energy (Energimyndigheten) during spring 2017.

The top targets of CCGEx during the next phase 2018-2021 are: increased gas exchange and turbocharging efficiency (by e.g. maximize the charge pressure, enable efficient thermodynamic cycles, minimize aerothermodynamic losses); more efficient and smarter EGR systems; integrated waste heat recovery (WHR); enhance the hybridization potential for a better response & efficiency under transients which will be organized under three research areas.

## Introduction

In 2013, the Swedish Energy Agency decided on a new financing period 2014–2017 for the competence centers under the Swedish Combustion Engine Consortium (SICEC), related to internal combustion engine technology. For the internal combustion engine center of KTH (CICERO 2006–2009, CCGEx 2010–2013), this period means that the center is steaming through its third financing round. The purpose of the annual report of 2017 is to present the current situation and an introduction to the next phase.

## Background

The Competence Center for Gas Exchange (CCGEx) (previously CICERO), was initiated in 2006 as a third competence center in the field of internal combustion engine technology.

Sweden has a strong engine industry, which, to survive, is dependent on being able to renew its products so that the industry is at the forefront among international competitors when it comes to environmental and energy related requirements. The current trend, with ever stricter emission requirements – which are more and more focused on CO<sub>2</sub> emissions, minimizing the use of energy, increasing the proportion of biofuels and hybrid engines – means that the margins for the components of the engine, system and processes are decreasing.

This means that the Swedish engine industry is facing a number of big challenges, in the form of requirements for higher efficiency in engines, tighter optimizations, the reducing of emissions and strong international competition.

The road to taking on these challenges is via a transition to a more knowledge and calculation based way of working, less dependent on prototype testing and solutions based on practice and trial and error.

This makes for a strong need to identify, understand, and in an innovative way work with the underlying physical processes used in the systems and components required by future highly efficient internal combustion engine concepts.

Players in the Swedish engine industry have been early adopters of supercharging, and are strong in this field from an international perspective. The significance of this field is increasing as new internal combustion systems require high EGR-percentages and boost pressures. Valve systems with variable opening and closing times, as well as lifters, are becoming more and more prevalent. To remain competitive, it is important that the industry is continuously attracting strong competence in the field. This includes expert knowledge as well as researchers with relevant skills. The field Gas Exchange and Supercharging is specific to Competence Center Gas Exchange (CCGEx) and exclusive for KTH – it is not covered by any of the other competence centers.

The purpose of CCGEx is to carry out academic research with the highest quality in the field Gas Exchange in the Internal Combustion Engine, in close collaboration with the Engine Industry, and thereby effectively contributing to an efficient, sustainable and competitive transport system based on efficient alternative fuels adapted to engine systems combined with electrification.

By making use of advanced methods for analyses, measurements and synthesis, the physical understanding of basic relevant phenomena is set to increase. Through this increased understanding,



CCGEx at the Royal Institute of Technology (KTH) • [www.ccgex.kth.se](http://www.ccgex.kth.se)

researchers in CCGEx will be able to identify new technical possibilities and solutions in gas exchange, EGR systems, supercharging and after treatment systems.

### Long-term vision, mission and strategy

The vision with CCGEx is to make possible the change from extensive physical testing to innovative virtual development using predictive simulation tools developed on physics-based understanding of phenomena.

Within CCGEx, *a multidisciplinary and integrated research is promoted*, which combines dedicated competences, expertise and facilities in *gas dynamics, acoustics, and engine technology*. It is based on extensive knowledge of fluid mechanics, turbocharging and combustion engine technology and includes both fundamental and applied experiments and simulations. The starting point for the formulation of research projects are challenges with the current propulsion systems for automotive applications.

The overall goal is to enable knowledge based and efficient design of next generation clean propulsion systems with focus on advanced gas exchange technologies.

### Organization

The Center is a combined effort between KTH, the Swedish Energy Agency, the Swedish automotive companies (i.e. Scania CV, Volvo Cars, and Volvo GTT), and the turbocharging manufacturer BorgWarner Turbo Systems Engineering GmbH in Germany.

The involved departments at KTH are the Department of Machine Design (Internal Combustion Engines), Department of Mechanics (Computational and experimental fluid mechanics), and Department of Aeronautical and Vehicle Engineering (The Marcus Wallenberg Laboratory for Sound and Vibration Research). The complementary and consistent views within the organization as well as the set-up of the working environment promote cooperation across group boundaries and with industry.

The Center is organizationally placed on the Industrial Engineering and Management (ITM) School. The Board of CCGEx is composed of representatives of all parties involved in the Center. CCGEx is headed by a director and two deputy directors with the help of the Research Management group. Presently, the Research Management group (LG) consists of director, deputy-directors, representatives of the CICERO & ICE Labs, student representative and young faculty and researchers actively involved the Center's activities.

The Research Management Team is advised by the Scientific Council (VR), formed of faculty at KTH (professors from the involved departments), and by the Industry Reference Group (specialized personnel from CCGEx's industry partners). Both the Scientific Council and the Industry Reference Group are acting as consultative bodies for the management team and will ensure the scientific level and relevance of the Centre's research areas and projects.

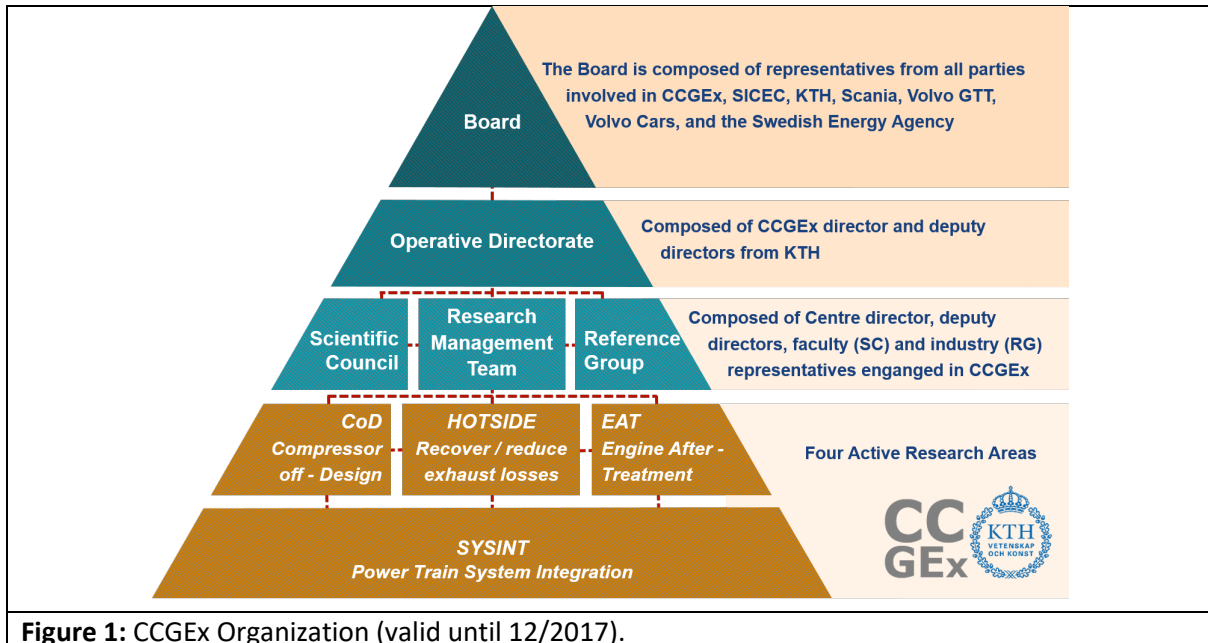

**Figure 1:** CCGEx Organization (valid until 12/2017).

As shown in the diagram above (Fig. 1), there are four research areas active in the Center, namely: "Cold Side: Compressor off Design - CoD", "HOTSIDE", "Engine After Treatment - EAT", and "Power Train System Integration - SYSINT".

The majority of research within CCGEx is conducted by Doctoral students (including Industry PhD students) under faculty guidance and supervision. At the end of their studies these will earn a Licentiate and / or a Doctoral Degree. Post-doctoral students or Researchers were/are also involved in Center's research activities but in a smaller number.

The main advisors/supervisors for the conducted projects are Associate Professors and Professors part of LG and/or VR. The pursued projects within CCGEx are using the broad expertise available within the Center and therefore it is aimed that as many projects as possible will involve an assistant supervisor with a complementary profile other than that of the main supervisor. At the same time it is important that within each research area, one can early and continuously seek the possibility of working together and involve industry partners, thus being able to utilize the expertise and resources of all the participants within the Center. Thus, there is a strong collaboration with the identified industry working groups, which are linked to the four CCGEx active research areas and individual projects. These working groups meet regularly to discuss the division of labor and project results, as well as new research and project ideas.

In addition to the research activities funded through CCGEx, there are also a few associated projects and complementary activities, funded from extramural funding (e.g. FFI, CSC).

Within Center's activities and functions, the following persons were engaged during 2017:

#### Board

Sören Udd	SICEC Chairman
Jan Wikander	KTH
Daniel Söderberg	KTH since 09/2016

Mikael Lindström	KTH until 09/2016
Jonas Holmborn	SCANIA since 09/2016
Lucien Koopmans	VCC until 09/2017
Carolin Wang - Hansen	VCC since 09/2017
Håkan Persson	VCC since 09/2017
Johan Wallesten	Volvo GTT
Anders Johansson	Swedish Energy Agency

#### CCGEx Directorate

Director	Anders Christiansen Erlandsson / MFM
Deputy director	Mihai Mihaescu / Mekanik
Deputy director	Mats Åbom / MWL

#### Management Group

Anders Christiansen Erlandsson	MFM
Mihai Mihaescu	Mek
Mats Åbom	MWL
Christophe Duwig	Mek
Bengt Fallenius	Mek/CICERO Lab
Mikael Karlsson	MWL
Bertrand Kerres	MFM (PhD Stud. representative) until 06/2017
Shyang Maw Lim	Mek (PhD Stud. representative) since 06/2017
Christer Spiegelberg	MFM

#### Scientific Council

Anders Christiansen Erlandsson	MFM
Mihai Mihaescu	Mek
Mats Åbom	MWL
Henrik Alfredsson	Mek/CICERO Lab
Hans Boden	MWL
Andreas Cronhjort	MFM
Christophe Duwig	Mek
Jens Fransson	Mek/CICERO Lab

#### The Research Team

Research Area "Compressor off Design - CoD"	
Mihai Mihaescu	Project Leader
Raimo Kabral	PhD Student, MWL, until 06/2017
Bertrand Kerres	PhD Student, MFM/Mek, until 06/2017
Elias Sundström	PhD Student, Mek
Asuka Gabriele Pietroniro	Ind. PhD Student, Volvo Cars, Mek/MWL
Valeriu Dragan	Post-doc, Borg-Warner project, Mek
Research Area "HOTSIDE"	
Mihai Mihaescu	Project Leader
Shyang Maw Lim	PhD Student, Mek
Marcus Winroth	PhD Student, Mek/CICERO Lab
Ted Holmberg	PhD Student, MFM
Nicholas Anton	Ind. PhD Student (Scania), MFM

Research Area "EAT"	
Mikael Karlsson	Project Leader
Ghulam Mustafa Majal	PhD Student, MWL/Mek
Zhe Zhang	PhD Student, Associated project, MWL
Arun Prasath	PhD Student, MFM
Mireia Altimira	Researcher, Mek, until 05/2017
Research Area "SYSINT"	
Anders Christiansen Erlandsson	Project Leader
Senthil Mahendar	PhD Student, MFM
Sandhya Thantla	PhD Student, MFM WHR associated project

### Measurable Outcomes

CCGEx deliverables and results are measurable through publications, participation in conferences, education and examinations of MSc and PhD students, as well as through the involvement of CCGEx faculty within undergraduate education program. To this should be added the knowledge built within the Center, the exchange of information, experience and resources, respectively among all partners involved in the Center's activities on both experimental and simulation campaigns. This includes as well transfer of information, data, and resources from the industry partners in form of in-kind contributions to CCGEx. The following table represents a summary of the main measurable outcomes delivered by CCGEx during the year of 2017.

<b>Doctoral theses (HT2016-HT2017)</b>	<b>3</b>
Sundström, E. (2017)	<i>Flow Instabilities in Centrifugal Compressors at Low Mass Flow Rate</i> , PhD thesis, KTH Mechanics, ISBN 978-91-7729-555-6, US-AB, Stockholm, Sweden. <a href="http://kth.diva-portal.org/smash/get/diva2:1157882/FULLTEXT02.pdf">http://kth.diva-portal.org/smash/get/diva2:1157882/FULLTEXT02.pdf</a>
Kabral, R. (2017)	<i>Turbocharger Aeroacoustics and Optimal Damping of Sound</i> . PhD thesis. KTH MWL, ISBN 978-91-7729-442-9, Stockholm, Sweden. <a href="http://kth.diva-portal.org/smash/get/diva2:1096314/FULLTEXT01.pdf">http://kth.diva-portal.org/smash/get/diva2:1096314/FULLTEXT01.pdf</a>
Kerres, B. (2017)	<i>On Stability and Surge in Turbocharger Compressors</i> , PhD thesis, KTH MFM, ISBN 978-91-7729-378-1, US-AB, Stockholm, Sweden. <a href="http://kth.diva-portal.org/smash/get/diva2:1093727/FULLTEXT01.pdf">http://kth.diva-portal.org/smash/get/diva2:1093727/FULLTEXT01.pdf</a>
<b>Licentiate theses</b>	<b>2</b>
Winroth, M. (2017)	<i>On gas dynamics of exhaust valves</i> . Licentiate thesis, KTH Mechanics, Stockholm, Sweden.
Lim, S.M.	<i>Flow and heat transfer in a turbocharger radial turbine</i> . Licentiate thesis, KTH Mechanics, Stockholm, Sweden.
<b>MSc theses</b>	<b>2</b>
Ceci, A. (2017)	Numerical analysis of evaporating sprays in a cross Transonic flow features in a nozzle guide vane passage. KTH Mechanics, Stockholm, Sweden.
Wenyuan, Y. (2017)	Development of fully vectorized potential flow solver for aeronautical application, KTH Mechanics, Stockholm, Sweden.



<b>Journal Publications</b>	<p><b>9</b></p> <ul style="list-style-type: none"> <li>- J. of Visualization</li> <li>- J. Sound Vibration</li> <li>- Experiments and Fluids</li> <li>- Flow Measurement and Instrumentation</li> <li>- Journal of Vibrations and Acoustics</li> <li>- Int. J. Turbomach. Propuls. Power</li> <li>- Flow, Turbulence and Combustion</li> <li>- SAE Int. J. Engines</li> <li>- Proc. Mtgs. Acoust.</li> </ul>
<b>Conference Contributions</b>	<p><b>6</b></p> <ul style="list-style-type: none"> <li>- SAE World Congress, Detroit 2017, USA</li> <li>- 12<sup>th</sup> European Conference on Turbomachinery Fluid Dynamics &amp; Thermodynamics, Stockholm, Sweden</li> <li>- ASME-Turbo Expo meeting, Charlotte, NC, USA</li> <li>- 70th Annual Meeting of the APS Division of Fluid Dynamics, Denver, USA</li> <li>- The 6th International Conference on Jets, Wakes and Separated Flows (ICJWSF 2017), Cincinnati, USA</li> <li>- Aerospace Europe, CEAS 2017 Conference, Bucharest, Romania</li> </ul>
<b>New Industrial Partners/Collaborations</b>	<ul style="list-style-type: none"> <li>- BorgWarner Turbo Systems Engineering GmbH, Kirchheimbolanden, German as partner in the Center</li> <li>- GE Oil &amp; Gas, Italy as collaborator</li> <li>- Wärtsilä Oy., Finland as partner in the center starting 2018.</li> </ul>
<b>Invited Seminars</b>	<ul style="list-style-type: none"> <li>- 12<sup>th</sup> European Conference on Turbomachinery Fluid Dynamics &amp; Thermodynamics, Stockholm, Sweden</li> <li>- Aerospace Europe, CEAS 2017 Conference, Bucharest, Romania</li> <li>- The 6th International Conference on Jets, Wakes and Separated Flows (ICJWSF 2017), Cincinnati, USA</li> </ul>

### Overview on Research Activities 2017

Over the year of 2017, CCGEx research efforts continued to be focused on the well-defined now research areas “Compressor off-design operation - CoD”, “HOTSIDE”, and “Engine After Treatment - EAT”. Moreover, two PhD students are active now in the new research area “Power train System Integration - SYSINT” introduced in 2016. For the specific projects see the Appendix.

## Research Area: Compressor off-Design (CoD)

*Summary:* Use advanced experimental and computational techniques with the purpose of predicting and understanding compressor surge.

A general flow chart depicting the research activities within the CoD research area is presented in Fig. 2. Over the last year, within this framework, the experimental efforts at CICERO & MWL Labs continued for the evaluation of compressor flow and aeroacoustics at design and off-design conditions. Complementing the experimental campaigns, 0D/1D modeling as well as 3D Computational Fluid Dynamics (CFD) using both steady-state and high-fidelity calculations (CFD) were intensified. As a result of these efforts within the CoD research area, three PhD theses were published during 2017.

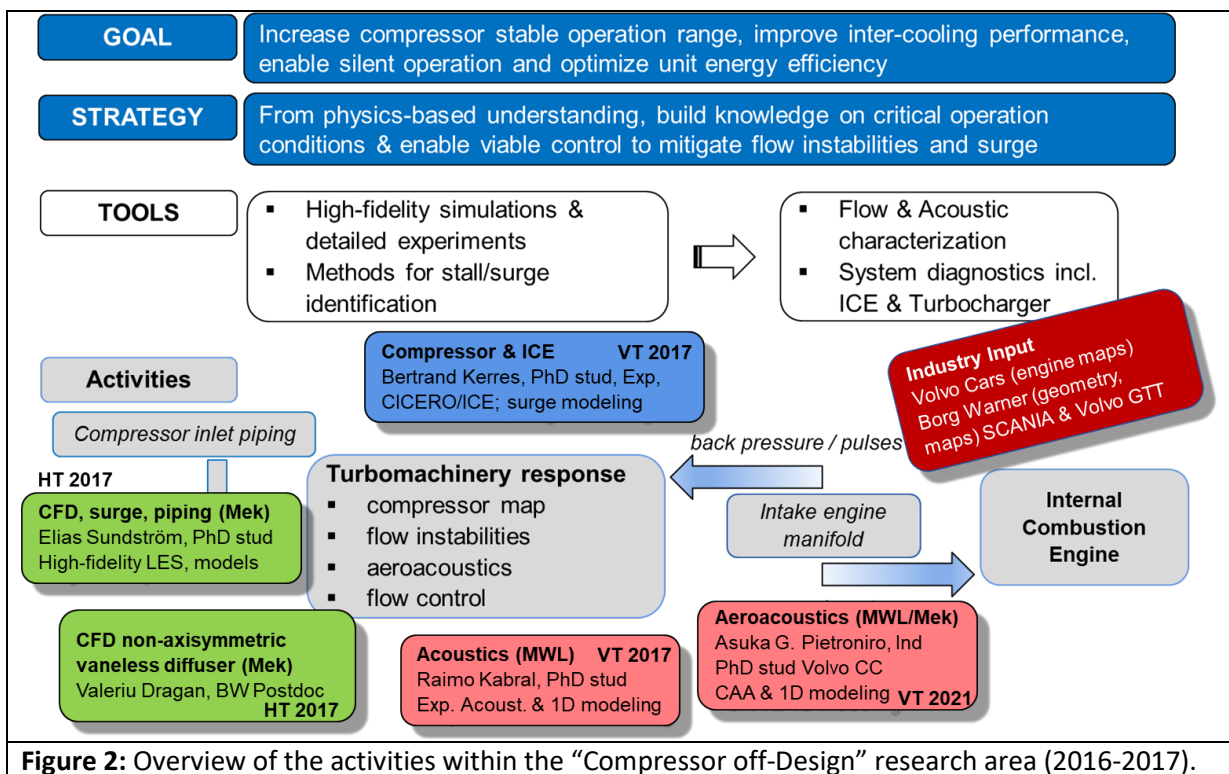

**Figure 2:** Overview of the activities within the “Compressor off-Design” research area (2016-2017).

Among the targeted research directions with the individual projects are: characterize and understand compressor behavior at low mass flow rates and high pressure ratios by assessing the flow structures and the developed flow instabilities; characterize and understand the aerodynamically generated sound in centrifugal compressors; assessment of compressor installation effects on compressor performance; identify surge precursors and develop more sensitive methods for surge prediction; assess the validity range of 0D/1D models for compressor performance under different operating regimes; develop improved techniques for studying scattering and generation of sound in centrifugal compressors; analysis of non-axisymmetric vaneless diffuser configurations and the impact on range of operability and performance. Most of the mentioned research directions will be continued within the next phase of CCGEx.

As depicted in Fig. 2, four PhD students and one post-doctoral student were involved in the CoD research activities during 2017.

### CoD - research highlights (2017):

The high-fidelity Large Eddy Simulation calculations and the usage of adequate mode decomposition techniques allowed detailed assessment of the compressor flow and developed instabilities at off-design operating conditions. It was also demonstrated the capability of extracting acoustic information from the LES data. Upstream installation effects (i.e. bended pipe geometries) on surge line were quantified experimentally. An assessment of the validity range for steady-state RANS & theoretical models for predicting compressor performance maps associated with particular compressors provided by BorgWarner was carried out.

The combined experimental and simulation efforts allowed establishing synergies between the different individual projects within the CoD research area. The experimental data obtained at the University of Cincinnati, USA (by Dr. Gutmark and his team) were extensively used not only for verifying and validating the CFD solver but also for assessing a new proposed surge criterion, which is based on monofractal/multifractal distinction of the pressure signal. The method, based on the Hurst exponent of the pressure signal, has been proposed as a more sensitive criterion for identifying precursor to surge instabilities. It has been applied on time-resolved pressure signals measured simultaneously at different locations in the compression system at Univ. of Cincinnati. It has been proved that an extended algorithm based on distinguishing between a mono- and multifractal pressure signal is shown to have potential as an early warning indicator for the occurrence of surge.

The results are summarized in several joint publications between the three departments (MWL-MFM-FI. Mech), some of them co-authored with our collaborators from University of Cincinnati.

The aeroacoustics measurements carried out in CICERO-Lab led to a successful determination of aero-acoustic coupling and characteristics in the system (centrifugal compressor and piping arrangement) at both design and off-design conditions. For such an arrangement, an efficient and compact noise control solution, based on the optimal flow channel wall impedance (Cremer impedance) was developed and proposed.

### Short & medium-term plans with CoD (i-COLD since 01/2018):

- Detailed experimental & computational efforts focused on the BorgWarner geometries (flow & acoustics)
- Include more realistic installation effects and assess sensitivity to the upstream / downstream perturbations (e.g. pressure pulses caused by engine breathing); analyse the impact on the onset of compressor instabilities.
- Include and assess the rotor dynamic effects.
- Evaluation / calibration /development of improved compressor surge models & assess the mechanisms for losses in centrifugal compressors
- Noise generation mechanisms; quantification of the acoustic noise sources at off-design; look into noise suppression technologies
- Address the impact of temperature on the flow-acoustic coupling in the system.
- Recruit one PhD student to work on “Variable boosting system response to upstream/downstream installation effects and perturbations”, using computational methods.

### “Research Area: HOTSIDE

*Summary:* **H**OListic approach **T**argeting to reduce/recover exhaust losses and increase **S**park Ignited & **D**iesel Engines performance (HOTSIDE). Integrated use of 1D and 3D flow modelling together with

measurements for assessing exhaust flow, maximize exhaust energy extraction and increase ICE efficiency.

The exhaust flow of the gas exchange process is highly 3D, intermittent, and unsteady. It presents features (e.g. secondary flow patterns, flow reversals) that are difficult to analyze using standard tools and methods and therefore not yet fully understood. Significant losses are associated with the developed structures in the exhaust flow, and assessing them in an accurate manner it is important. Moreover, turbocharger systems are used for recovering some of the energy of the exhaust gases and their performance is highly dependent on the upstream flow conditions (e.g. exhaust flow homogeneity, energy of the pulsating flow).

All the components in the exhaust system from the exhaust valves, exhaust ports, and turbine are so closely interlinked that they should be considered as one system from the gas exchange point of view. Moreover, any perturbations and changes in the exhaust flow upstream of turbocharger's turbine will change the overall performance of the turbocharger and thus engine performance (strong coupling with the cold - side).

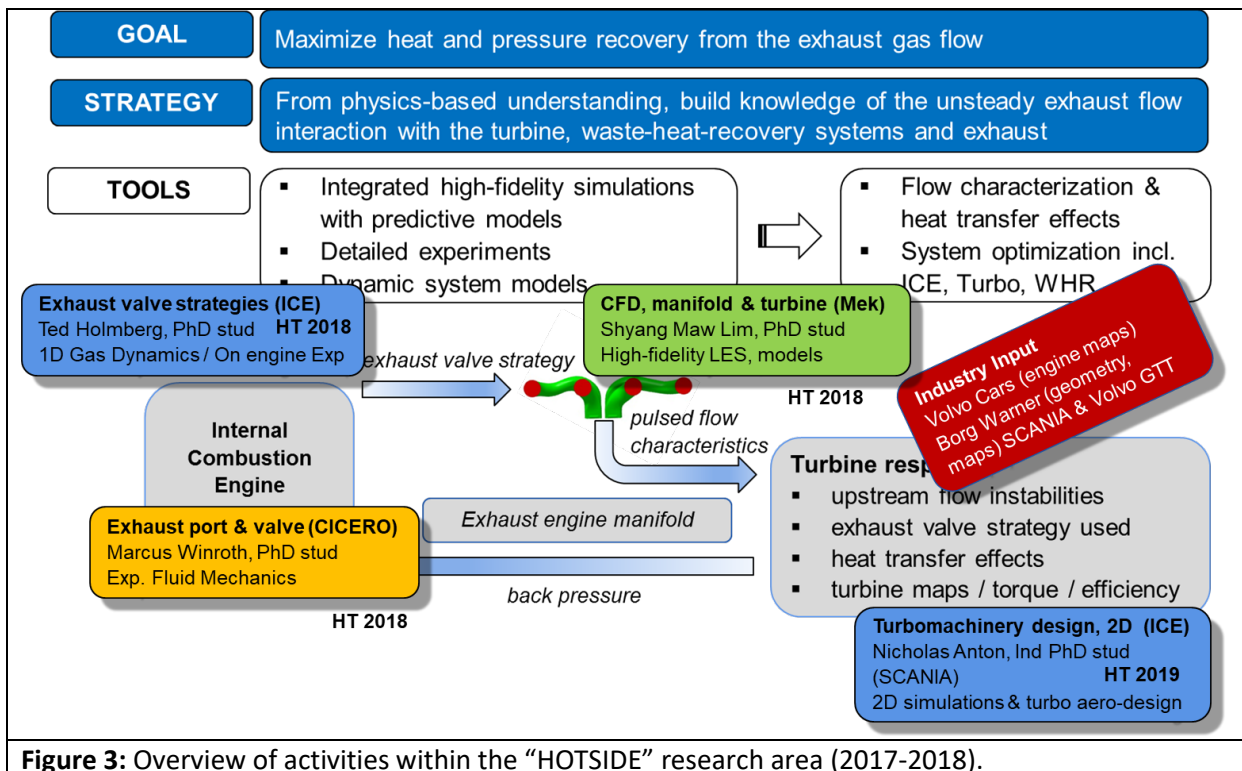

**Figure 3:** Overview of activities within the “HOTSIDE” research area (2017-2018).

The HOTSIDE project aims to improve understanding of the pulsatile exhaust flow and of its interaction with the radial turbine for a better usage of the exhaust flow energy available to be used (exergy). Both experimental and computational tools (1D & 3D, steady/unsteady) are used for characterizing the pulsatile behavior of the exhaust flow under different exhaust valve strategies. For the assessment of the turbine the approach considers different levels of integration and complexity with the upstream geometry and flow conditions. An overview of the project and of the research activities is presented in Fig. 3.

### HOTSIDE - research highlights (2017):

Among the research highlights one can mention the evaluation of the adiabatic & diabatic turbine performance under different flow scenarios (continuous and pulsating) using Detached Eddy Simulations-DES. The boundary conditions and temperature data are provided by industry for engine operating points of interest. An exergy based model is developed and applied on the DES data. The exergy method allowed quantifying the heat loss, the extracted power by the turbine, and the internal irreversibilities (viscous and thermal) in the entire exhaust system, or at sub-component level (e.g. exhaust manifold, scroll, turbine rotor, outlet pipe). This enabled studying the effectiveness of the available energy usage in the exhaust system.

Experimental efforts within CICERO Lab are focused on assessing the exhaust port flow characteristics and the impact of the exhaust valve opening profile as well as other variables (e.g. engine speed, pressure ratio, radial valve position) on the discharge coefficient. The discharge coefficient has been shown to have a strong dependency on both valve opening speed and pressure ratio. The static measurements overestimate the value of the discharge coefficient, thus indicating that neither the quasi-steady nor the pressure-ratio insensitivity assumption holds. It has been shown that the radial position of the valve does not have a significant impact on the discharge coefficient. The experimental efforts are complemented by the development of 1D computational models within GT-Power frame of work, where pressure dependent flow coefficients were implemented. Recently, Schlieren flow visualizations in the exhaust port were performed for different conditions and valve lifts. The flow visualizations indicate shock patterns are present in the exhaust port during the blowdown pulse and that the shock pattern is altered when using a static geometry (typically used during the gas-stand measurements).

1D engine simulations are performed also for evaluating engine performance for different turbine designs. Turbomachinery design software on a 1D and 3D basis are the main tools for the design process. Prototype hardware manufacturing and engine/gas stand testing are carried out at SCANIA. An initial campaign concerning assessing performance for two axial turbine designs and Twin-scroll turbines at SCANIA (CFD and Gas stand data comparisons) has been finalised. It involved steady flow gas stand measurements as well as a model-based studies.

### Short & medium-term plans with HOTSIDE:

- Dynamic measurements of the discharge coefficient: dynamic valve experiments with a double valve set-up; assess the influence of different valve lift profiles; data correlations with the Schlieren flow visualizations.
- Detailed unsteady computational efforts on the BorgWarner turbine integrated with the manifold with Boundary Conditions provided by Volvo Cars (VEP-HP engine; different exhaust valve strategies); Quantify the associated losses and impact on turbine performance for different exhaust valve strategies
- Recruit one PhD student to work on “Turbocharged engine performance optimization with focus on maximising energy transfer from hot-side to cold-side”, using computational methods
- Recruit a second PhD student, an experimentalist, to work on “Turbocharger turbine efficiency in steady and pulsating inlet flow”
- PhD theses defenses: Shyang Maw Lim (HT2018); Marcus Winroth (VT2019)

## Research Area: Exhaust After Treatment (EAT)

*Summary:* Study of fluid mechanics, multi-phase flow, heat transfer, and acoustics along the exhaust line of the engine with relevance to engine after treatment, without considering the catalysis.

The EAT research area is vast even though we do not enter the catalysis part. We have activities within two areas that fit well with the competences of the center:

1. Atomization and mixing of urea water solution (SCR) – a combined computational and experimental approach
2. Particle characterization and agglomeration (PCA)

The computational component of the SCR project has been a run as a pre-study that was finalized during 2016. A complementing experimental campaign (involving MWL, Mek, and MMF) has been carried out and finalized 05/2017. Even though SCR is a well-established technology—at least for heavy duty—and is in commercial use there are fundamental issues to address. One is the proper understanding of the introduction and mixing of the urea water solution into the exhaust stream. The approach of CCGEx has been to take a step back from applications and instead evaluate numerical schemes on very basic setups. One problem however, is the lack of good experimental reference data sets. A part of the project has therefore been to produce experimental data.

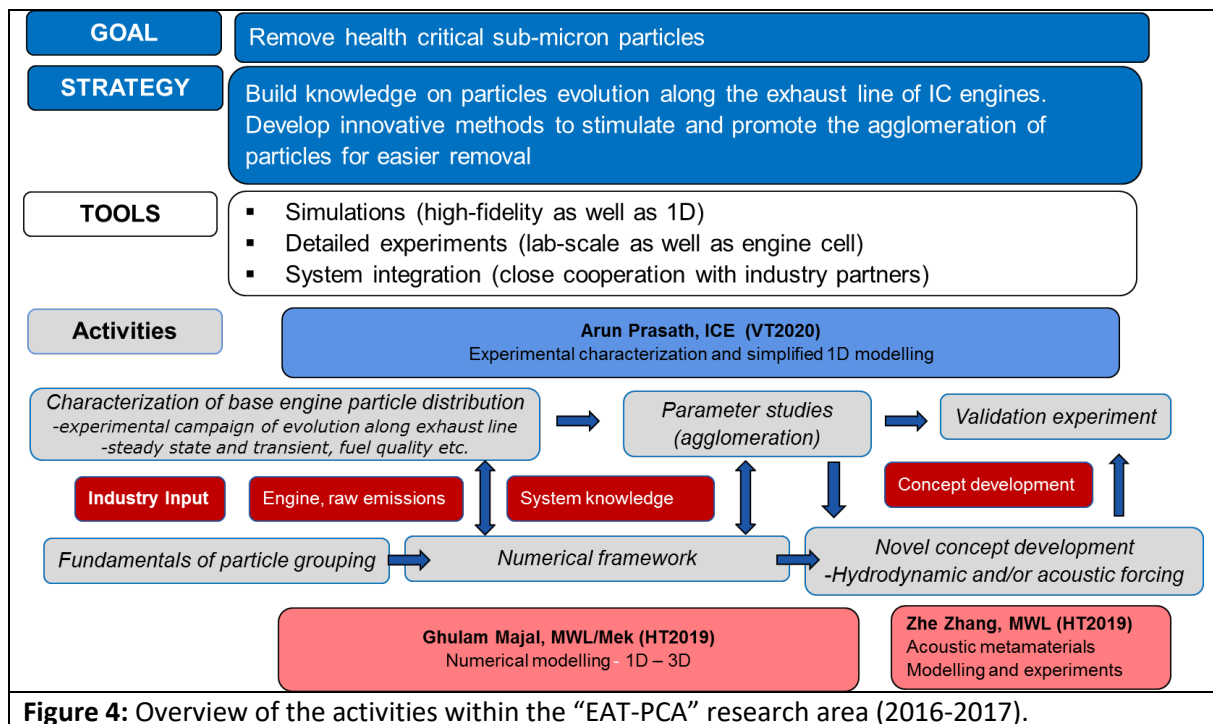

**Figure 4:** Overview of the activities within the "EAT-PCA" research area (2016-2017).

The major project in EAT is the particle characterization and agglomeration project. It is topic that has become increasingly important the last few years with engines producing more and more health critical sub-micron particles. This is also reflected in the legislation that now introduce limits on particle numbers. The project focus on understanding the evolution of particles along the exhaust line and the possible manipulation of the particles to make them agglomerate. A schematic overview of the PCA research area and is presented in Fig. 4.

### EAT - research highlights (2017):

Within the SCR project the experimental data set determined is a good contribution to the research community as a reference case. A known injector has been used to spray into a generic spray chamber with and without crossflow under a number of operating condition. This is the foundation we will use for further studies in the area.

The experimental characterization of particles has not started yet, we are in a preparatory phase where the engine and exhaust line is started up and instrumented. More work has been done on the numerical side. The 1D agglomeration modeling is finalized and has been improved to include influence of different engine pulses, varying agglomeration geometries as well as acoustic forcing.

The framework for using acoustic forcing to stimulate particle agglomeration has been put forward. It has been shown that the use of acoustic metamaterials (where one in this application change the speed of sound in the media) greatly improves the applicability of the technique.

### Short & medium-term plans with EAT:

- Startup of engine and first characterization of particle evolution in the exhaust line (steady state operating point)
- First hydrodynamic agglomeration prototypes to be tested
  - Designed for validation of 1D modeling.
- Experimental validation of “slow sound” concept derived.  
Experimental validation of particle agglomeration in flow ducts using acoustic forcing.  
High fidelity modeling of particle agglomeration

### Research Area: Power Train System Integration (SYSINT)

*Summary:* The system integration area (SYSINT) is aiming at facilitating the transfer to predictive model based engineering by improved system understanding.

As such the area is relying on a 1-D capable frame work well known to industry, while focusing on developing great lower order models of aggregated detailed data obtained from high-resolved simulations or experiments to better describe reality. Within the area and the projects running, the following topics will be treated:

- Combustion process & gas exchange system interactions.
- System efficiency – thermodynamic, mechanical, electrical
- Thermal integration & emissions reduction efficiency
- Component interactions
- Transients system dynamics & control  
New Concept assessment

An overview of the SYSINT research area and of the associated research activities is presented in **Fig. 5**.

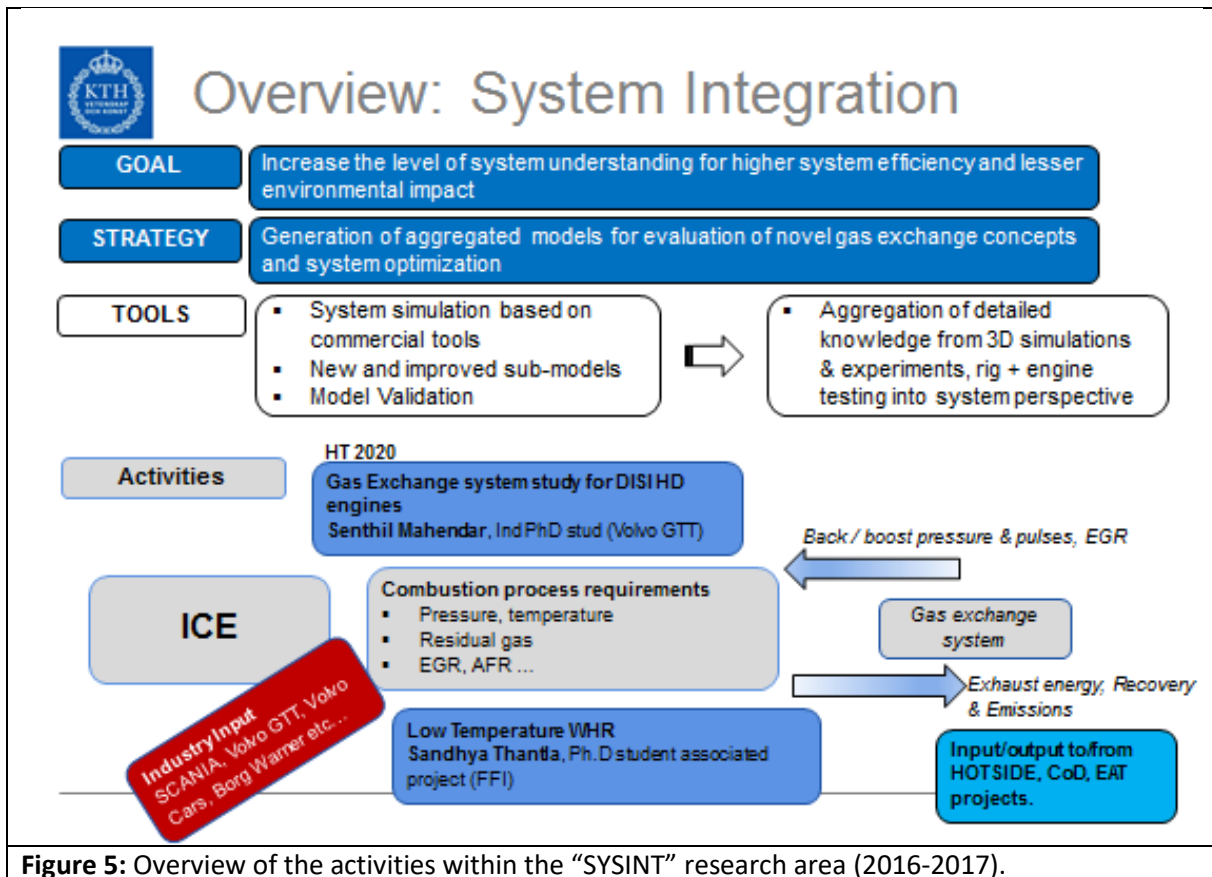

Figure 5: Overview of the activities within the “SYSINT” research area (2016-2017).

### SYSINT - research highlights (2017):

Activities completed:

- Paper Number SAE 2018-01-0907 “Challenges for Spark Ignition Engines in Heavy Duty Application - a Review” published in April 2018
- 1D simulation tool evaluation for combustion modelling (GT Power SI Turb) completed. Turbulence modelling seen to be crucial for accuracy. TKE data for future 1D modelling to be derived from closed cycle 3D CFD simulation
- Literature survey on expanders used in general Organic Rankine Cycle (ORC) applications and in automotive WHR
- Preliminary sensitivity analysis to understand the effects of mass flow rate, enthalpy drop and pressure ratio on the expander work output
- Energy analysis of a Miller engine using GT-suite software
- Simplified OD modelling of Scroll and Piston expanders to study the effects of built-in volume ratio on their performance

Short & medium-term plans with SYSINT:



- Experiments planned for HD SI engine on KTH single cylinder engine using ethanol and methanol port fuel injection.  
Part procurement ongoing. Test points include full load and part load with EGR sweeps. Fast burn will not be tested in the baseline since 3D CFD simulations of the designed bowl showed insufficient improvement of TKE close to TDC
- Combustion model tuning based on results from the experiment
- Performance analysis of Scroll and Piston expanders using detailed semi-empirical models
- Comparative performance study of Scroll and Piston expanders for the automotive WHR application

### Associated projects with CCGEx

During 2017, research continued with a few associated projects developed around CCGEx. These are summarized below.

**Project Title: “Selective Catalytic Reduction of NO<sub>x</sub> through injection of Urea-Water-Solution (UWS)”**

Project type: CCGEx Associated Project, PI: M. Karlsson

The purpose with this project has been the characterization of the spray formation and its interaction with the exhaust gas flow. The aim is to identify the main mechanisms driving the breakup and mixing of UWS droplets, in order to increase the NO<sub>x</sub> conversion efficiency under real driving conditions. The project combines numerical simulations and experiments, the latter being used to validate and/or complete the mathematical models used.

**Project Title: “In-cylinder flow of a Diesel water-analogue engine”**

Project type: CCGEx Associated Project, PI: P.H. Alfredsson

The project aims to assess how swirl and tumble depend on the dynamics of the valves/piston as well as how they vary between cycles. Particle Image Velocimetry (PIV) measurements as well as numerical simulations are performed at KTH Mechanics in collaboration with the leading car industry in Sweden in order to tackle some of these questions. Experiments (planar PIV) were performed at one tumble plane examining the effect of piston presence, Reynolds number as well as the dynamic motion of the inlet valves.

**Project Title: Meta-materials for sound in ducts**

Project type: CCGEx Associated PhD project (CSC=Chinese Science Council), PI: M. Åbom

Meta-materials are engineered materials with properties not found in nature. Typically, such materials are realized in the long wave length limit of a periodic system with local resonances. Such devices can be designed to create new types of efficient and compact silencers e.g. by reducing the sound speed. Such slow sound devices could perhaps also be applied in connection with acoustic agglomeration. In the present PhD project, the student has started to work on this last possibility.

## Finances

In the current period 2014-2017, financing – and as a result available means within CCGEx – increased to 8 MSEK/year in cash contributions from the Swedish Energy Agency. The same contribution, in the form of one cash part and a larger part in kind, was secured from KTH. In the new period, the three main industrial partners increased their commitment to a total of 1.7 MSEK/year and partner (as cash and in kind contributions). During 2016, Borg Warner joined the center through an accession agreement and sponsored a post-docs under 2016/2017. The transactions were handled directly between Borg Warner and Mechanics department.

A lot of work has also been put into the preparation and carrying out of the research projects, to come to an agreement on, and to plan for, the in kind contribution from partners (KTH and industry) that are under these commitments.

In the table below, the final financial report for 2017 can be found. Only major deviations from budget were that the center supported a lot of traveling both for conference participation and meetings with partners for preparing the new program proposal. Since no hot testing were planned for the CICERO lab the installation of the heater was postponed. In all, the center closed the year close to budget and the entire project very close to the project budget.

## Financial review 2017

		<b>Budget 2017</b>	<b>Actuals 2017</b>
IB2016		188 004	188 004
<b>INCOME</b>			
KTH medfinansiering		1 000 000	1 000 000
Energimyndigheten		8 000 000	8 000 000
Scania		800 000	800 000
Volvo Car		600 000	600 000
Volvo GTT		800 000	800 000
Annan finansiering		0	0
<b>TOTAL INCOME</b>		<b>11 200 000</b>	<b>11 200 000</b>
<b>COSTS</b>			
Föreståndare	ACE 40%, MMK	800 000	800000
Vice Director 10%	Mats Åbom, MWL	180 000	180000
Vice Director 10%	Mihai Mihaiescu, Mekanik	180 000	180000
Admin assistent 25%	Johanna Olsson	200 000	226163
LG members		150 000	150000
IAB + CCGEx day		100 000	100000
Styrelseordförande	Sören Udd extern	200 000	200000
Resekostnader		35 000	266634
Driftkostnader (repr m)		50 000	61057
Verksamhetsutveckling, internat		45 000	0
Konferens		50 000	50000
<b>SUB TOTAL</b>		<b>1 990 000</b>	<b>2 213 854</b>
<b>CICERO Lab</b>			
Labchef , 20%	Bengt Fallenius	300 000	300000
Lokalhyra lab	Mekanik	120 000	120000
Driftkostnader lab		30 000	30000
Utrustning / infrastruktur/avskrivning		20 000	20000
Installation heater		200 000	0
<b>SUBTOTAL CICEROLab</b>		<b>670 000</b>	<b>470 000</b>

<b>ITM MMK</b>			
<b>Gas Exchange systems</b>	ACE	450 000	450000
	Senthil		
Gas exchange for DISI HD	Mahendar	150 000	150000
Cold Side: compressor off design, "compressor maps for engine installation"	Bertrand Kerres	475 000	475000
iHOT : "Interaction between ICE exhaust pulses and Turbine"	Ted Holmberg	950 000	950000
EAT (Exhaust After Treatment)	Arun Prakatsh	950 000	950000
<b>iHOT : "TurboMachinery interaction with exhaust pulses"</b>	Nicholas Anton	150 000	150000
Labdrift		250 000	250000
Material		100 000	100000
<b>SUBTOTAL MMK</b>		<b>3 475 000</b>	<b>3 475 000</b>
<b>SCI, MWL</b>			
"TurboMachinery Acoustic Fl.Sim"	Asuka ...	150 000	150000
EAT Particulate grouping	Ghulam Majal	950 000	950000
EAT: coordinator / researcher	Mikael Karlsson	360 000	360000
<b>SUBTOTAL MWL</b>		<b>1 460 000</b>	<b>1 460 000</b>
<b>SCI, MEKANIK</b>			
iHOT : "Exhaust Valve Flow"	Marcus Winroth	950 000	950000
Cold Side: coordinator / researcher	Mihai Mihaescu	450 000	450000
iHOT: coordinator / researcher	Mihai Mihaescu	450 000	450000
Cold Side: "Large Eddy Simulations of the 3D Flow in a Centrifugal compressor"	Elias Sundström	950 000	950000
iHOT: "Flow and Heat Transfer Effects on the Efficiency of a Radial Turbine "	Shyang Maw Lim	950 000	950000
<b>SUBTOTAL MECHANICS</b>		<b>3 750 000</b>	<b>3 750 000</b>
<b>TOTAL COSTS</b>		<b>11 345 000</b>	<b>11 368 854</b>
<b>RESULT 2017</b>		<b>-145 000</b>	<b>-168 854</b>
<b>OUTGOING BALENCE</b>		<b>43 004</b>	<b>19 150</b>

### Improvements during the year

The collaboration between the doctoral students from the different departments involved in the CoD research area (i.e. KTH-MWL, KTH-Machine Design, and KTH-Mechanics) was significantly strengthened during 2017. This led to several joint publications (published or accepted for publication).

Moreover, the CCGEx PhD students and postdocs are holding regular meetings and seminars with a frequency of cca. 4 every year. There is agreement among the participants that four seminars per year is a good frequency. The aims are team building and improving knowledge transfer within the group. Each seminar is concluded with a dinner.

During 2016, three seminars have been held, and a fourth one is scheduled. The first seminar was held on 19/02. Topic was a LabVIEW programming course. The participants were asked to develop a simple pressure transducer calibrator in LabVIEW, under supervision from the PhD students more experienced in LabVIEW. Short presentations were given on the concept of a state machine and NI CompactRIO real-time programming. The second seminar was held on 22/06. Topic was a course in the CFD environment StarCCM+, from mesh generation to solving the equations to post-processing. After a short presentation by the teacher, the participants were asked to simulate a simple case under supervision. The third seminar was held on 24/08. Topic was the SWOT-like analysis of the competence centre from the PhD students' perspective, and brainstorming ideas for improvement. The fourth seminar is scheduled for 04/11. Since the sharing of programme code was found to be lacking in the SWOT analysis, the topic will be an introduction to bitbucket, a code sharing platform and version control system. A practice session on good coding practice in MATLAB is also planned.

## Partners development

Interaction with Industry (Scania, Volvo Cars, Volvo GTT, BorgWarner Turbo Systems)

Each of the research areas benefits from a strong interaction with the industrial partners and collaborators. Researchers, doctoral students, industry representatives are interacting every 4 to 6 weeks with the purpose of presenting and discussing the latest updates on each of the specific research areas and to clarify the near- and far-future planned research activities. The industry partners and collaborators have the possibility of joining these technical meetings on-line via telephone and web based programs. Thus, most of the meetings are on-line meetings. However, several face-to-face meetings took place as well over the year of 2017.

BorgWarner (BW) Turbo systems Engineering GmbH, Kirchheimbolanden, Germany became a new collaborator for CCGEx during 2015. During the month of October 2016, BW and all involved parties within CCGEx signed the Accession Agreement. As a result, BW financed the research activities of one Postdoctoral student (Valeriu Dragan) within the CoD research area for one year (2016-2017). His project and research findings were briefly summarized in this report. Moreover, during 2017 within the same research area, an Industrial PhD Student from Volvo Cars Corporation AB (Asuka Gabriele Pietroniro) joined CCGEx (01/2017). These added naturally also to the in-kind contributions (e.g. hardware, geometries, and hot-gas stand experimental data) received from our industry partners during 2017.

Extensive high-fidelity calculations of several compressor and turbine geometries under various operating conditions from peak efficiency to near surge conditions have been carried out using the computing facilities at the KTH-Mechanics, the Swedish National Infrastructure for Computing (SNIC) and PDC at KTH. KTH has the capabilities to operate on several high performance clusters for single

and parallel computations KTH<sup>1</sup>. A variety of commercial solvers as well as developmental research (“in-house”) Large Eddy Simulation (LES) based codes can be used, which incorporate among other features, e.g. sliding mesh capabilities and aeroacoustics prediction capabilities. The available commercial software programs include among other Star-CCM+ by CD-Adapco™, ANSYS ICEMCFD®, ANSYS CFX, Fluent®. Additionally, advanced post-processing methods developed “in-house” are in use at KTH-Mechanics, e.g. Proper Orthogonal Decomposition (POD) and Dynamic Mode Decomposition (DMD) techniques. The data processing and visualization is accomplished using e.g. ParaView, Tecplot®, Matlab, OpenDX and “in-house” developed software.

The computational efforts within the framework of CoD & HOTSIDE research areas are doubled by the experimental activities within the CICERO Lab and MWL Lab on assessing compressor flow and aeroacoustics, as well as on measuring in-cylinder and exhaust port flows. Extensive experimental data sets obtained at the University of Cincinnati, USA on an academic compressor rig were used for verifying and validating the computational tools used within CCGEx. Moreover, the method based on the Hurst exponent of the pressure signal, developed within CCGEx as a more sensitive criterion for identifying precursor to surge instabilities, has been applied on the time-resolved pressure signals measured simultaneously at different locations in the compression system at University of Cincinnati.

### List of Publications (2017)

(For a complete list of publications please check <https://www.ccgex.kth.se/publications>)

**Kabral, R. and Åbom, M.** (2018) *Investigation of turbocharger compressor surge inception by means of an acoustic two-port model*. Journal of Sound and Vibration, 412, 270-286.

[doi.org/10.1016/j.jsv.2017.10.003](https://doi.org/10.1016/j.jsv.2017.10.003)

**Winroth, P.M., Ford, C.L., Alfredsson P.H.** (2017) *On discharge from poppet valves: effects of pressure ratio and system dynamics*. Experiments in Fluids. [doi.org/10.1007/s00348-017-2478-8](https://doi.org/10.1007/s00348-017-2478-8)

**Ford, C. L., Winroth, P.M., Alfredsson, P.H.** (2017) *Vortex-meter Design: The Influence of Shedding-body Geometry on Shedding Characteristics*, Flow Measurement and Instrumentation. [doi.org/10.1016/j.flowmeasinst.2017.12.004](https://doi.org/10.1016/j.flowmeasinst.2017.12.004)

**Anton, N., Genrup, M., Fredriksson, C., Larsson, P.-I., Erlandsson-Christiansen, A.** (2017) *Exhaust Volume Dependency of Turbocharger Turbine Design for a Heavy Duty Otto Cycle Engine*. ASME Paper, GT2017-63641. [doi:10.1115/GT2017-63641](https://doi.org/10.1115/GT2017-63641)

**Knutsson, M. and Åbom, M.** (2017) *Acoustic modelling of charge air coolers*. Journal of Vibrations and Acoustics 139(4), 041010. [doi: 10.1115/1.4036276](https://doi.org/10.1115/1.4036276)

**Winroth, P.M., Ford, C.L., Alfredsson, P.H.** (2017) *On the Dynamics of Discharge Process*. 70th Annual Meeting of the APS Division of Fluid Dynamics, Denver, A25-00002.

**Sundström, E., Mihaescu, M., Giachi, M., Belardini, E., Michelassi, V.** (2017) *Analysis of Vaneless Diffuser Stall Instability in a Centrifugal Compressor*. Int. J. Turbomach. Propuls. Power. 2(4), 19. [doi:10.3390/ijtp2040019](https://doi.org/10.3390/ijtp2040019)

**Zhang, Z., Kabral, R., Nilsson, B., and Åbom M.** (2017) *Revisiting the Cremer impedance*. Proc. Mtgs. Acoust. 30, 040009. [dx.doi.org/10.1121/2.0000619](https://dx.doi.org/10.1121/2.0000619)

---

<sup>1</sup> <http://www.pdc.kth.se/>, <http://www.nsc.liu.se/>, <http://www.lunarc.lu.se/>

**Sundström, E., Semlitsch, B., Mihaescu, M.** (2017) *Generation Mechanisms of Rotating Stall and Surge in Centrifugal Compressors*. Flow, Turbulence and Combustion. [doi.org/10.1007/s10494-017-9877-z](https://doi.org/10.1007/s10494-017-9877-z)

**Kerres, B., Cronhjort, A., Mihaescu, M., and Stenlaas, O.** (2017) *A Comparison of On-Engine Surge Detection Algorithms using Knock Accelerometers*. SAE Technical Paper 2017-01-2420. [doi:10.4271/2017-01-2420](https://doi.org/10.4271/2017-01-2420)

**Sundström, E., Kerres, B., Sanz S., Mihaescu, M.** (2017) *On the Assessment of Centrifugal Compressor Performance Parameters by Theoretical and Computational Model*. ASME Paper, GT2017-65230.

**Heide, J., Karlsson, M., and Altimira, M.** (2017) *Numerical Analysis of Urea-SCR Sprays under Cross-Flow Conditions*. SAE Technical Paper 2017-01-0964. [doi:10.4271/2017-01-0964](https://doi.org/10.4271/2017-01-0964)

**Lim, SM., Dahlkild, A., and Mihaescu, M.** (2017) *Exergy Analysis on Turbocharger Radial Turbine with Heat Transfer*. Proceedings of 12<sup>th</sup> European Conference on Turbomachinery Fluid Dynamics & Thermodynamics, Stockholm, ETC2017-267.

**Kerres, B., Sanz, S., Sundström, E. and Mihaescu, M.** (2017) *A comparison of performance predictions between 1d models and numerical data for a turbocharger compressor*. Proceedings of 12<sup>th</sup> European Conference on Turbomachinery Fluid Dynamics & Thermodynamics, Stockholm, ETC2017-350.

**Kabral, R., El Nemr, Y.A., Ludwig, C., Mirlach, R. and Åbom, M.** (2017) *Experimental acoustic characterization of automotive twin-scoll turbine*. Proceedings of 12<sup>th</sup> European Conference on Turbomachinery Fluid Dynamics & Thermodynamics, Stockholm, ETC2017-363.

**El Nemr, Y.A., Veloso, R., Girstmair, J., Kabral, R., Åbom, M., Schutting, E., Dumböck, O., Ludwig, C., Mirlach, R., Koutsovasilis, P. and Masrane, A.** (2017) *Experimental investigation of transmission loss in an automotive turbocharger compressor under ideal and real engine operating conditions*. Proceedings of 12<sup>th</sup> European Conference on Turbomachinery Fluid Dynamics & Thermodynamics, Stockholm, ETC2017-298.

**Holmberg, T., Cronhjort, A., and Stenlaas, O.** (2017) *Pressure Ratio Influence on Exhaust Valve Flow Coefficients*. SAE Technical Paper 2017-01-0530. [dx.doi.org/10.4271/2017-01-0530](https://dx.doi.org/10.4271/2017-01-0530)

**Kerres, B., Mihaescu, M., Gancedo, M., and Gutmark, E.** (2017) *Optimal Pressure Based Detection of Compressor Instabilities Using the Hurst Exponent*. SAE Int. J. Engines 10(4). [dx.doi.org/10.4271/2017-01-1040](https://dx.doi.org/10.4271/2017-01-1040)

**Zhang, Z., Abom, M., Boden, H., and Karlsson, M.** (2017) *Particle Number Reduction in Automotive Exhausts Using Acoustic Metamaterials*. SAE Int. J. Engines 10(4). [dx.doi.org/10.4271/2017-01-0909](https://dx.doi.org/10.4271/2017-01-0909)

Note: The Doctoral students involved in the Center are carrying out the educational and research activities as established in the Individual Study Plans

### New funding opportunities (2018)

Several CCGEx faculty members were involved in generating the application “Enabling virtual design for future power train systems - E4Future”, for answering to the European Training Network (ETN) / Innovative Training Networks (ITN), Call identifier: H2020-MSCA-ITN-2018.

The project will be coordinated by Politècnica de València. The Consortium is formed by Academia and Industry from Austria, Belgium, France, Greece, Germany, Italy, Spain, and Sweden.

### Outlook - CCGEx program period (2018-2022)

During 2016-2017 intense work within the Center has been dedicated to finalize the program proposal for CCGEx phase III. The program proposal formulated and submitted, considered also the inputs obtained from the strategic discussions held with all stakeholders during 2016-2017.

Among the targets of CCGEx during the next phase one can mention: increased gas exchange and turbocharging efficiency (by e.g. maximize the charge pressure, enable efficient thermodynamic cycles, minimize aerothermodynamic losses); more efficient and smarter EGR systems for optimized, diluted & cold combustion; integrated waste heat recovery (WHR); enhance the hybridization potential for a better response & efficiency under transients.

The CCGEx activities (2018-2021) will take place under three research areas. They were formulated to answer to specific research questions. The three research areas and the formulated specific research questions are:

#### 1) i-COLD: Integrated COLD-side

- Which are the mechanisms & key factors leading to stall onset in centrifugal compressors?
  - Impact of upstream / downstream perturbations and installation effects on compressor stability and performance
  - Assess & mitigate flow phenomena leading to stall/surge
- Understand compressor system’s components, their interactions, for an optimal, variable boosting system
  - Impact of hybridization; EI-booster/power-boost system integration; Two stage/sequential system integration
  - Optimised component interaction/connections
- Which are the mechanisms for the aerodynamically generated noise in compressor systems?
  - Assess & mitigate the dominant acoustic sources

#### 2) i-HOT: Integrated HOT-side

- Understand the impact of pulsating hot flows on component & connections (interaction between components)
  - Identify and mitigate aero- and thermal losses
  - Identify the available enthalpy (exergy)
- How to take advantage of the pulsating conditions to maximize the average turbine power output?
- Understand the heat-harvesting mechanisms from pulsating hot gas
  - Pressure drop penalties vs. heat transferred
  - Fluctuations impact on performance
  - New concepts for WHR



### 3) i-SYS: Integrated System Studies

- Understand the characteristics of gas exchange systems for effective, highly boosted, diluted (EGR) cold combustion with renewable fuels & near zero emissions.
- How to leverage the potential of hybridization to increase efficiency, transient response, and integrate WHR.
- How to simulate real drive emissions (RDE) in laboratory and virtual real time environments to achieve near zero emissions.
- Understand particle characterization and treatment.
- Urea SCR revisited – from fundamental understanding to system view.

Five PhD projects and four post-doctoral ones were initiated. It is expected that the five PhD students will be recruited during 2018.

## Posters



KTH CCGEx

# The Hurst Exponent as a Compressor Surge Criterion

Bertrand Kerres

[kerres@kth.se](mailto:kerres@kth.se)

The aim of this project is to investigate the Hurst exponent as a new criterion for compressor surge. It is based on the fractal properties of an underlying time series, e.g. a compressor pressure measurement signal. Investigations show that the Hurst exponent has potential as a surge indicator. The advantages compared to other signal characteristics like the standard deviation are that it decreases from 0.5 for pure white noise to 0 for noise-free oscillations, and that the method can easily be generalized.

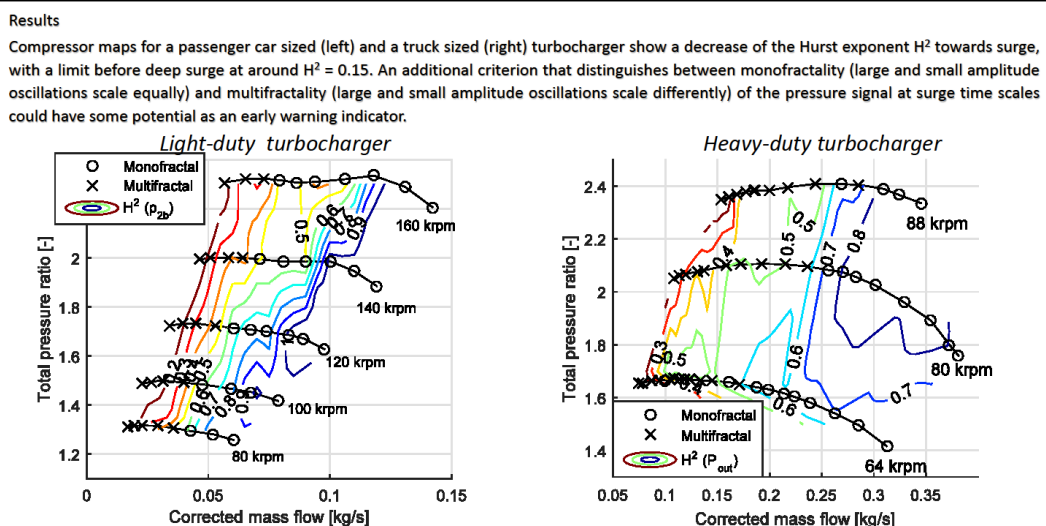
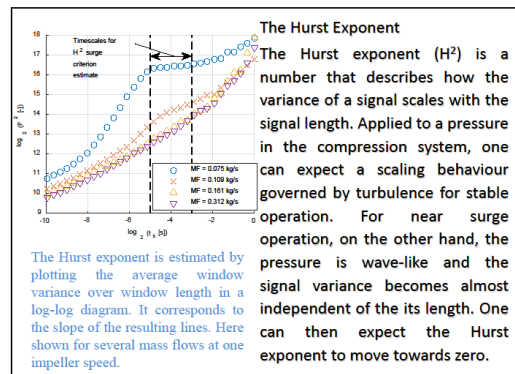
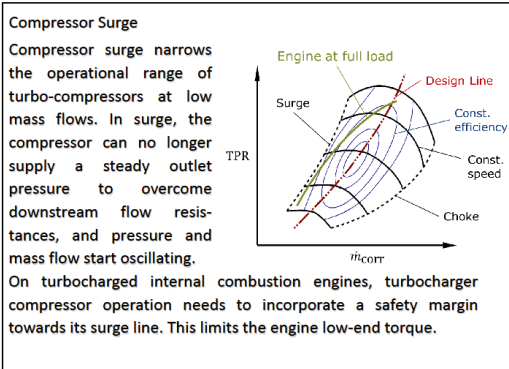

**Summary and Conclusion:**

Main advantages of the Hurst exponent as a surge indicator are its well-defined limit of zero for pure oscillations, and the flexibility due to the different orders and different signal detrending options. The main drawback compared to e.g. the power spectrum is the complexity of the underlying concept.

**Acknowledgement:**  
Supervisors: Andreas Cronhjort, Mihai Mihaescu



KTH CCGEX

# Engine optimized turbine design

Nicholas Anton M.Sc

[nicholas.anton@scania.com](mailto:nicholas.anton@scania.com)

Turbocharging is a very common way of increasing both engine torque/power as well as improving engine efficiency and is found on almost every modern engine. The focus of this project is turbocharger turbine design for heavy duty internal combustion engines. The aim is to characterize the turbine operating conditions on engine and how to make best use of the remaining energy present in the exhaust gases. This is investigated by considering different design strategies for the turbine taking into account the pulsatile nature of the engine. Naturally this project is a part of the iHOT-side of CCGEX, but is also a collaboration between Scania CV AB and KTH.

### Introduction and Motivation:

The turbocharger is a very common component on engines used nowadays both for Otto and Diesel cycle engines. The main drivers are improved torque/power levels, engine efficiency, possibility to downsize etc. The inherent unsteadiness of the internal combustion engine is posing a challenge for matching with steady flow turbomachinery such as a turbocharger turbine. On engine conditions is by no means the ideal for such a steady flow device. By utilizing the exhaust energy from the engine cylinders, the turbine can drive the compressor providing boost pressure as well as reduced or gain in pumping work. The result from this project can immediately become of use for achieving better engine performance, increasing power/torque while improving efficiency and emissions.

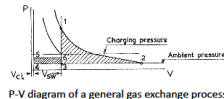

P-V diagram of a general gas exchange process.[1].

[1] Turbocharging the Internal Combustion Engine, fig. 1.6 s.5, Watson&Janota, 1982.

### Setup:

The basic tools for this project is 1D engine simulation and 1D/3D turbomachinery design software. The idea is to provide a process from an initial 1D turbine design to a fully defined, manufacturable 3D prototype geometry for gas stand evaluation and/or engine testing. In the design process, the geometry specification will evolve from 1D/3D evaluation using both turbomachinery and engine simulation.

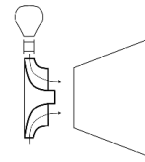

Meanline 1D turbine stage

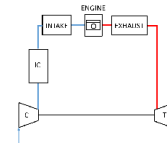

Simplified 1D engine model

### Results:

Initially this project has been focusing on turbocharger turbine performance evaluation from turbocharger gas stand. A twin-scroll turbine stage, which is common for engine pulse utilization, has been modelled on a 1D level. A methodology was developed based on basic 1D flow and turbine theory for evaluating the main parts of the turbine stage, the volute, rotor and diffuser. This will facilitate a component analysis, characterizing the performance of the stage which is normally not deduced. An analysis on this level is very helpful as a mean of validating a design, to gain insight into aerodynamic trends and to guide the designer towards possible areas of improvement. A case study, analysing a heavy-duty twin scroll turbocharger stage was conducted using this methodology. Test data from gas stand was gathered for different flow admissions and speeds, the methodology implemented in MATLAB and subsequently an analysis of turbine stage parameters. Results show good correlation with studies in the area and comparison with a commercial meanline 1D turbomachinery software running the same conditions.



Diffuser part

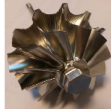

Rotor part



Volute part

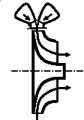

Admission into a twin scroll turbocharger turbine, meridional view

Further work will be focusing on the design aspect as such for a heavy duty CNG Otto-engine, designing a complete turbocharger and investigating the turbine operation at on engine conditions. The idea is to investigate turbocharger turbine design point parameters in order to gain efficiency in the very unsteady engine environment.

### Summary and Conclusion:

The twin-scroll turbine stage study mentioned above show good potential of enhancing the turbocharger turbine evaluation. Providing several new dimensions of analysing compared to traditional "mapping" of the turbine stage. This can be used for improving turbocharger turbine stage efficiency and thereby engine performance.

### Acknowledgement:

Main supervisor Prof. Dr. Anders Erlandsson Christiansen, Royal Institute of Technology, KTH



Co supervisor Prof. Dr. Magnus Genrup, Lund Faculty of Engineering LTH



Industrial supervisor Expert engineer Mr. Per-Inge Larsson, Scania CV AB





KTH CCGEx

# Rotating Machines and innovative noise control

Raimo Kabral

[kabral@kth.se](mailto:kabral@kth.se)

The goal of this project is to develop improved techniques for studying scattering and generation of sound in centrifugal compressors. In particular, to extend previous work to more in depth investigation in unstable flow and sound field coupling including the in-duct sound generation. The experimental work is performed in the unique turbocharger test facility at KTH CCGEx by implementing advanced experimental tools and procedures. In addition, innovative flow channel liners consisting of micro-perforated plates or metallic foams are treated in complementary noise control studies. The investigation involves experimental study of acoustic liners on dedicated high temperature test rig and numerical analyses by means of Comsol Multiphysics® FEM software. The efforts are being taken to determine high temperature acoustical properties as well as to find techniques for the optimization of such noise control solutions. The work is part of a Marie-Curie network on aero-acoustics named FlowAirS (see [www.flowairs.eu](http://www.flowairs.eu)).

### Introduction and Motivation:

Turbochargers (TC) are essential components of modern "rightsized" internal combustion engine units. Although, the principle of TC originates from the early 20th century, two restrictive problems are still encountered today – the high level of compressor noise and compressor surge.

In order to achieve effective noise control, the accurate source characterization data i.e. the acoustic source data independent of the coupled flow-channel system, must be known first. Moreover, it is also assumed herein that generated sound and passive acoustic properties of the compressor contour could play significant role in the surge initiation process. Therefore, the acoustic properties of the TC, including acoustical scattering and sound generation as well as the effects of flow-acoustic coupling, are studied herein by means of detailed and accurate methods. In addition, the optimization techniques for innovative noise control materials, enabling compact jet effective noise control, are also developed.

### Setup:

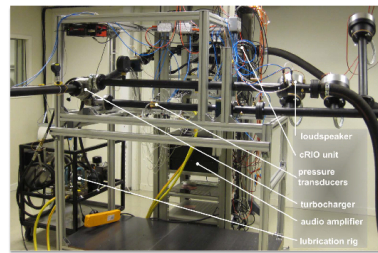

The TC acoustic characterization facility at KTH CCGEx (See the photo) have been used to determine accurate acoustical scattering and source data (full two-port data) at realistic operating conditions.

### Results:

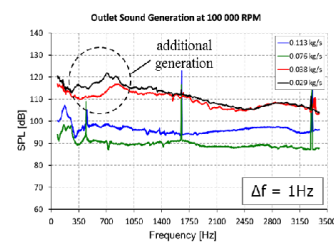

The sound pressure level (SPL) spectrum of generated sound in the outlet branch of the compressor at constant rotor frequency. The mass flow is varied from maximum to minimum i.e. near surge operation.

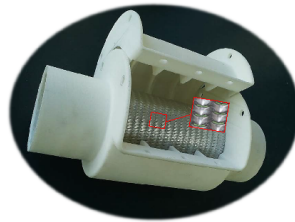

The prototype of compact silencer consisting of straight flow channel made of micro-perforated panel (MPP), and adjoining cavity. Such compact silencer concept can provide a very high level of sound dissipation.

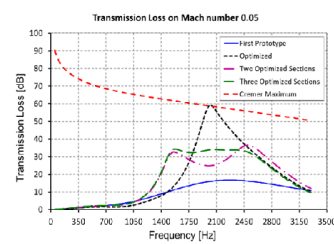

Sound transmission loss spectra from the optimization of the compact silencer prototype. The optimization technique is based on so called Cremer optimal acoustic impedance concept.

### Summary and Conclusion:

A high level of noise is increased further while operating the compressor near surge conditions which may require additional noise control. An effective noise control can be achieved by means of compact silencer concept when optimized according to the specific sound source. Moreover, the straight-flow compact silencer can provide a fibrous-free noise control with a negligible penalty of pressure drop.

### Acknowledgement:

Prof. Mats Åbom, Marcus Wallenberg Laboratories for sound and vibration research (MWL), KTH.  
 Prof. Hans Bodén, MWL, KTH.  
 Dr. Magnus Knutsson, Volvo Car Corporation.



KTH CCGEx

# Heavy Duty DISI Gas Exchange Processes with Alternative Fuels

*Senthil Krishnan Mahendar*

*mahendar@kth.se*

This project aims to provide insight on the requirements of the gas exchange system architecture while using renewable alcohol fuels in Direct Injection Spark Ignition (DISI) process. Efficiency improvement and emission reduction of the DISI engine will be studied using 1D engine modelling with experimental validation. This study focuses on Heavy-Duty (HD) engines constrained to run at stoichiometric conditions to reduce complexity of the after-treatment system.

## Introduction and Motivation

Compression Ignition (CI) diesel engines is a preferred fuel choice for HD engines as they achieve high efficiency and returns reduced operating cost for fleet owners.

For Euro 6, the typical Diesel after-treatment systems used are Particulate Filters (DPF) and Selective Catalytic Reduction (SCR) with aqueous urea dosing. These after-treatment systems in general constitute about 45% of the total engine cost even though they have managed to reduce emissions to about 90% of Euro 3 standards.

Alcohols when used in DISI process has the potential for high efficiency and low particulate emissions. When combined with stoichiometric operation, this could also reduce after-treatment cost of a commercial vehicle by using only a three-way catalyst.

## Objective

- To recommend a gas exchange system architecture based on the advantages that alcohols offer as fuel in DISI process
- To obtain the limits of operation in alcohol fuelled LD engines and to compare the scalability to HD Engines for various parameters
- Contribute to improved modelling methods based on analysing the deficits of current methods and comparing experimental results

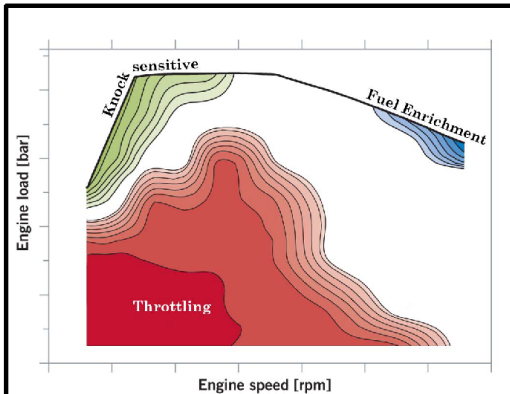

Limits of SI engine efficiency – Gasoline

## Alcohol fuels

- High octane – less knocking tendency ( + )
- High latent heat of vaporization – lower fuel enrichment ( + )
- Lower stoichiometric A/F ratio – higher throttling ( - )

**Improvement of throttling is key for alcohol fuelled engine's efficiency**

## Research activities (2016-17)

- Detailed 1D engine model development
- Generation of experimental data to validate the 1D model (including trace knock, COV and particulates)

## Research questions (2016-17)

- What is the attainable load and efficiency in DISI operation? What are the limits?
- How sensitive is alcohol combustion to residual gases (cooled and uncooled)?  
[Comparison of knock and misfire limits with gasoline and projection of gas exchange system architecture for alcohols.]



KTH CCGEx

# Gas Dynamics of Exhaust Valves

Marcus Winroth

[marwin@mech.kth.se](mailto:marwin@mech.kth.se)

Due to tougher legislations on exhaust emissions from combustion-engine vehicles, the development of more efficient engines with lower emissions is an important topic within the vehicle industry. The exhaust gases are hot and at high pressure and are thus rich in energy. Some of this energy may be recovered using a turbocharger. To maximize the energy recovery, the engine system needs optimisation. When optimizing an engine system it is common to use one-dimensional, semi-empirical models. In such models, complex flows (such as the flow past the exhaust valves) may be represented by a straight pipe-flow with a corresponding discharge coefficient ( $C_D$ ).

### Introduction and Motivation:

In order to decrease computational time when designing and optimizing engine systems, it is common to use 1D simulations. In these simulations complex fluid problems are simplified using mapped coefficients to describe the flow. These maps are obtained experimentally, where the experiments are typically performed with constant valve lifts at low pressure ratios. This project focuses on experimentally testing the assumptions (quasi-steadiness and independence of pressure ratio) made when determining the discharge coefficient ( $C_D$ ) of the exhaust valve. This was done by performing exhaustion experiments at different pressure ratios, with both a dynamic and a static valve.



$$C_D = \frac{\dot{m}_{actual}}{\dot{m}_{ideal}}$$

### Setup:

The photo shows the setup for the dynamic valve experiments. The valve is operated using a linear motor, which allows for a controllable valve lift profile. The rig has a straight outlet pipe (which exhausts to atmosphere) connected to the exhaust port approximately 1 diameter downstream of the valve seat. The outlet pipe can be changed to test the effects of downstream conditions. The pressure is measured in the cylinder, in the valve seat and at two positions in the outlet pipe. The initial temperature in the cylinder is also monitored. This makes a dynamic measurement of the mass flow possible (1), by measuring the pressure in the cylinder as function of time and determining the mass that have left the cylinder using the isentropic relationship (2) and the gas law (3).

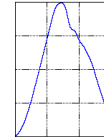
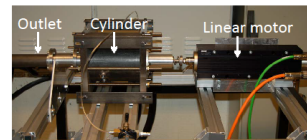

$$\frac{dm}{dt} = \frac{V}{\gamma R T_0} \left( \frac{p_0}{p} \right)^{(\gamma-1)/\gamma} \frac{dp}{dt} \quad (1)$$

$$\frac{p}{p_0} = \left( \frac{T}{T_0} \right)^{\gamma/(\gamma-1)} \quad (2)$$

$$m(t) = \frac{V}{R} \frac{p(t)}{T(t)} \quad (3)$$

### Results:

The left figure shows  $C_D$  as a function of valve lift for different initial cylinder pressures, for an equivalent engine speed of 900 rpm. It can from this plot easily be seen that an increase in pressure causes a decrease in  $C_D$ . In the right figure  $C_D$  for different equivalent engine speeds is plotted. The value of  $C_D$  shows a large dependency on engine speed, where a faster opening speed leads to a higher value of  $C_D$ . In both figures  $C_D$  measured with a static valve can be seen to generally overestimate the value of  $C_D$ .

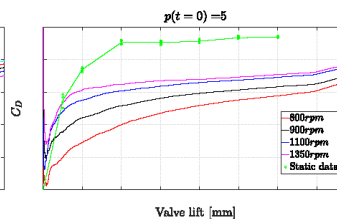
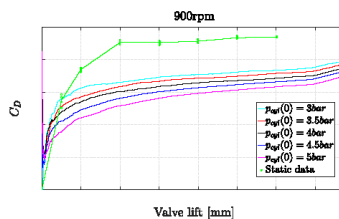

### Summary and Conclusion:

In order to investigate the quasi-steady assumption, for exhaust flows, experiments have been performed using both a static and a dynamic valve.

Results show a large dependence on valve opening speed and pressure ratio. It also shows that measurements using a static valve overestimates the value of  $C_D$ , compared to the dynamic valve. Indicating that any attempt to represent the exhaust flows, from a real engine, with a steady measurement of  $C_D$  is bound to be flawed.

Supervisors: Prof. Henrik Alfredsson, Dr. Ramis Örlü





KTH CCGEX

# Valve Strategies and Exhaust Pulse Utilization

Ted Holmberg

[tedho@kth.se](mailto:tedho@kth.se)

This project aims to improve the understanding of how the pulsating exhaust flow from the internal combustion engine interacts with the exhaust turbine of the turbocharger. Variable valve actuation on the exhaust side is used to influence the pulse properties to find optimum turbine power as a function of pumping losses for a given load point. The interaction will be primarily studied with 1-D simulation supported by tests on a single-cylinder diesel engine equipped with a hydraulic variable valve actuation system and a six-cylinder engine equipped with a fixed geometry turbocharger.

### Introduction and Motivation:

To improve fuel efficiency of turbocharged internal combustion engines it is desirable to reduce pumping losses. In the case of Heavy-Duty diesel engines this is done by carefully matching turbocharger specification to the piston engine. Generally the valve train of the Heavy-Duty engine is fixed and the turbocharger has a fixed geometry. Peak efficiency is therefore achieved in a narrow operating range and has to be weighed against other parameters such as transient response to a load step and durability.

This work will study how fully variable valve actuation (VVA) on the exhaust side can be used to create a more efficient charging system. Because of this new degree of freedom the valve strategy can be optimized for fuel efficiency in some load points and transient response in others.

Presently the only cost-effective way to simulate an entire engine is by 1D simulation tools. Flow losses over complex geometry such as valves and ports are described by flow coefficients. These are measured in steady-flow test rigs at low pressure drops. In an engine the pressure differential between cylinder and exhaust port are much larger at the time of exhaust valve opening. The influence of this has been investigated in the current study.

### Air flow bench:

A steady-flow test rig designed to determine flow coefficients for a cylinder head. The flow coefficient is calculated by dividing the measured mass flow with the ideal mass flow through a reference area for a given pressure ratio ( $p_1/p_2$ ). This is done for different valve lifts and used for input in 1D simulation tools.

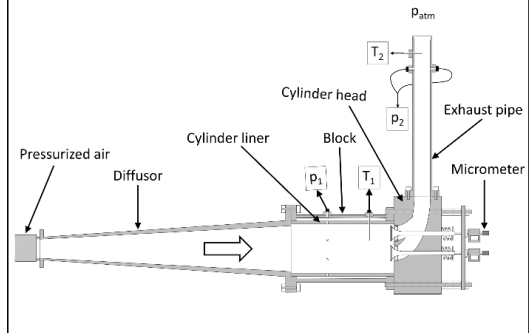

### Results:

The exhaust valve flow coefficient are shown for two cases with different valve seat angles and valve shapes.

Only one of the two exhaust valves are open. The reference area is the exhaust port outlet area.

The case with the 45 degree valve seat appears to have a larger pressure dependence.

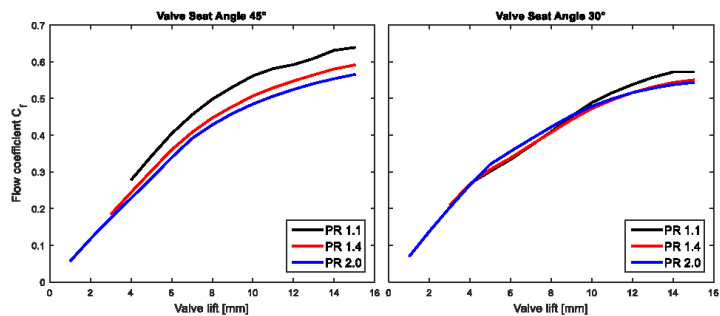

### Summary and Conclusion:

The pressure ratio appears to influence the flow coefficient differently based on valve and valve seat geometry.

### Acknowledgement:

Supervisor: Andreas Cronhjort  
Co-Supervisor: Anders Christiansen Erlandsson





KTH CCGEx

# Control of particle agglomeration with relevance to after-treatment gas processes

*Ghulam Mustafa Majal*

*gmmajal@kth.se*

The project aims to find methods for stimulating agglomeration of particles in internal combustion engine exhaust systems by manipulation of the hydrodynamic and acoustic fields. An understanding of the evolution of particulate characteristics (e.g. particle mass, particle number, size distribution) as traveling along the exhaust system components and connections with relevance to modern engines is needed. The enhancement of the aforementioned understanding will be developed with the usage of advanced computational tools and models.

**Introduction and Motivation:**

Modern internal combustion engines show a tendency to form fine particles that are prone to penetrate through the human respiratory system and cause cardiovascular as well as neurological problems. This project aims at deriving predictive models for the manipulation of particles in the exhaust line through the use of forced pulsatile flow conditions and/or acoustic fields.

**Setup:**

The numerical setups will initially be based on simplified 1D models. The goal then would be to carry out sensitivity studies in order to analyze the effect of different parameters on agglomeration. Later on more complex models as well as 2D and 3D geometries will be considered.

Initial numerical experiments based on the 1d model presented in Katoshevski et al. 2005 have been done. The model looks at an oscillating Stokesian flow. An additional simplification has been made by only taking into account the drag force.

In order to obtain grouping within this model two important non dimensional parameters were noted. The beta parameter which compares the mean flow field with the amplitude of the oscillations. Secondly, the alpha parameter which encapsulates the inertial effects due to the size of the particle.

**Results:**

Starting off from the model equation for the velocity of the host gas, the oscillations due to the engine are taken to be sinusoidal. A grouping and non grouping map using the alpha and beta parameters is made for the sinusoidal oscillations from the engine. These idealized oscillations are then compared to the actual oscillations coming from the engine. The leftmost figure below shows that a simple sinusoidal oscillation under estimates the transition from grouping to non grouping. The rightmost figure shows the result of applying different waveforms for the oscillations due to the geometry and their effect on grouping.

**Summary and Conclusion:**

Tests have been carried out extensively to understand the effects of the crucial non dimensional parameters and their effect on grouping. Next steps would involve moving out of the 1D scenario and look at more realistic 2D and 3D modeling. This would also help in getting a more accurate feel for the effects of the oscillations due to the geometry of the pipe being utilized for particle agglomeration.

**Acknowledgement:**

This project is supervised by Docent Mihai Mihaescu, KTH Department of Mechanics, Prof. Mats Åbom, KTH Marcus Wallenberg Laboratory, Docent Lisa Prahll Wittberg, KTH Department of Mechanics and Dr. Mikael Karlsson, KTH Marcus Wallenberg Laboratory.

The CCGEx partners Scania AB, Volvo AB and Volvo Cars are acknowledged for their support.

The Swedish Energy Agency is acknowledged for their funding.





KTH CCGEX

# Particle grouping in vehicle exhaust system with acoustic method

Zhe Zhang

zhez@kth.se

Exhaust particulate matter (PM) from vehicular traffic is a major health and environmental issue. Increasingly strict regulations of vehicle emission have been introduced and extensive efforts have been put onto the control of PM. One potential solution is particle grouping, which can dramatically reduce particle numbers. An acoustic grouping method is proposed here, which gives the relationship between the speed of sound, the mean flow velocity and the amplitude of the acoustic particle velocity for particle grouping to be feasible. To satisfy this relationship, the so-called acoustic metamaterials, which can help control, direct and manipulate sound waves, are applied.

### Introduction and Motivation:

That the interaction between particles and oscillating flows may lead to the formation of particle groups yields the possibility of grouping. The oscillating flow may simply be hydrodynamic or, as assumed here, created by sound propagation. An analysis on particle motions inside a sound field leads to the conclusion that if

$$|\beta| = \left| \frac{c - V_a}{V_b} \right| < 1$$

then particle grouping is feasible. In the formula,  $c$  is the sound phase velocity,  $V_a$  is the mean flow velocity and  $V_b$  is the acoustic particle velocity. Given the practical situation inside vehicle exhaust pipes (the mean flow velocity is around 50 m/s), the speed of sound should be reduced dramatically to satisfy this grouping condition. To address such challenge, the so-called acoustic metamaterial is recommended to slow down the propagation of sound wave.

### Setup:

Acoustic metamaterials refer to artificially fabricated composite structures designed to control, direct and manipulate sound waves. Although normally designed as periodic structures, their properties do not just rely on periodicity but rather uniformly distributed local resonances so that in the limit of low frequencies an equivalent medium is created, which can lead to negative mass density ( $\rho$ ) and bulk modulus ( $K$ ). Given that  $c = (K/\rho)^{1/2}$ , possibly the speed of sound can be slowed down. A schematic diagram of the metamaterial prototype is illustrated below.

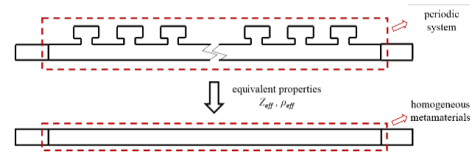

### Results:

Based on two extraction methods, the effective speed of sound in the metamaterial is calculated and found to be slow in certain frequency ranges (illustrated in the figure on the left), thus providing the possibility to satisfy the grouping condition. The metamaterial model is further plugged into a vehicle exhaust system, with a running engine and a tailpipe connected to its two ends. The sound field inside the metamaterial part is decomposed and the trajectories of 20 evenly distributed particles in the exhaust pipe are calculated (illustrated in the figure on the right). Two clear particle groups can be found.

Effective Speed of Sound

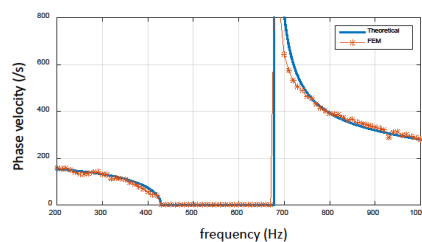

Particle Trajectories

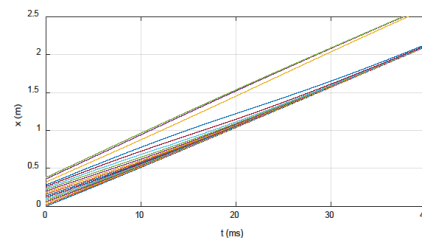

### Summary and Conclusion:

A new approach to the analysis of particle grouping in a 1D acoustic field is suggested and the grouping condition is provided. In the case of grouping, the sound speed should be of the same order as the mean flow velocity. To realize such condition, locally-reacting-based acoustic metamaterials are introduced and the effective speed of sound is found to be very small in certain frequency ranges. An example of particle grouping inside a vehicle exhaust system with a plugged-in metamaterial part is shown.

### Acknowledgement:

I really appreciate the supervision and instruction given by Prof. Mats Åbom, Prof. Hans Bodén and Mikael Karlsson. Also, thanks very much for the support from all the sponsors.

VOLVO



SCANIA

BorgWarner





KTH CCGEX

# Flow Exergy Analysis on a Turbocharger Radial Turbine

Shyang Maw Lim

[smlim@kth.se](mailto:smlim@kth.se)

This project aims to assess the exhaust flow impact on heat transfer and performance of a turbocharger radial turbine operating under continuous and engine-like flow conditions by using Detached Eddy Simulation (DES) approach. Adiabatic and different temperatures are imposed on the wall to mimic different level of heat transfer scenarios. In addition to the commonly used energy conservation approach to relate the amount of heat loss to the turbine performance, Exergy (or Availability) concept is adopted to quantify the losses associated with heat transfers. The outcomes of exergy analysis enables us to identify the components where exergy destructions occur and rank order them according to significance. Furthermore, exergy analysis provides information about the effectiveness of exhaust gas energy utilization in the turbine system.

### Introduction and Motivation:

In practice, the turbocharger is not thermally insulated and the heat transfer affects its performance. Moreover, the heat transfer is affected by the flow characteristics. Within the turbocharger context, it is common to quantify the amount of heat transfer and the associated performance change by energy conservation principle. However, energy conservation idea alone is inadequate for quantifying the losses associated with heat transfer. In this study, Exergy concept derived from mass and energy conservation principles together with the Second Law of Thermodynamics are adopted to extend heat transfer analysis of a turbocharger radial turbine.

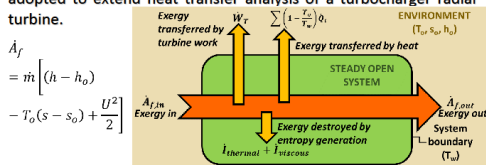

### Setup:

The computational setup replicates the turbine operating at maximum efficiency point on a low speed line in hot gas stand. Nevertheless, simulations are on-going for turbine operating under pulsating engine-like conditions. Different thermal conditions (i.e. adiabatic and constant wall temperature  $T_w$  [K]= 1002, 830 and 487) are imposed on all walls to model heat transfer. The rotation of the turbine wheel is handled by using Sliding mesh technique.

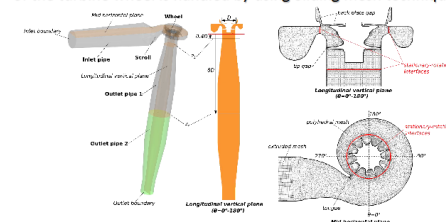

### Results:

1) Energy balance analysis shows that turbine power is sensitive, whereas pressure ratio is less sensitive to heat transfer.

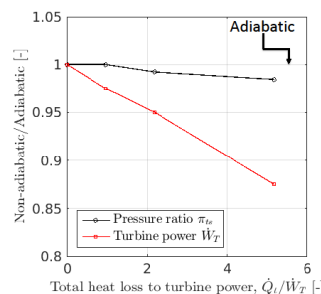

$$\dot{Q}_i = \sum \dot{Q}_i$$

$$W_T = \iint_{S_{wheel}} [(\vec{r} \times \vec{f}) \cdot \vec{\omega}] dS$$

$$\dot{Q}_i = \iint_{S_i} \vec{q} \cdot d\vec{S}$$

$$i_{thermal} = T_o \iiint_{V_{cv}} \frac{k}{T^2} (\nabla T)^2 dV$$

$$i_{viscous} = T_o \iiint_{V_{cv}} \frac{1}{T} \tau_{kj} \frac{\partial u_k}{\partial x_j} dV$$

2) Exergy analysis shows that heat transfer increases the (a) amount of exergy loss to the ambient via heat flow,  $\sum (1 - \frac{T_o}{T_w}) \dot{Q}_i$  (b) exergy destroyed due to thermal entropy generation,  $i_{thermal}$ . Nevertheless, there is still great potential to extract more exergy for useful work in the system.

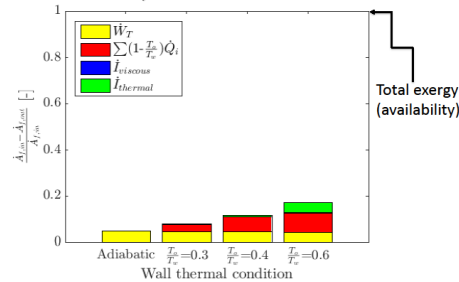

### Summary and Conclusion:

Different mechanisms of the heat transfer related losses for a turbocharger turbine can be quantified by looking at the exergy budget. Analysis based on the hot gas stand continuous flow condition shows that there exists great potential for better utilization of the hot gas energy resource. This highlights the needs for research and development in turbine design to harvest more flow exergy/availability. In near future, the exergy analysis will be extended and applied to turbine operating under engine-like conditions to assess how the upstream exhaust manifolds and flow instabilities affects the heat transfer and turbine performance.

### Acknowledgement:

Supervisors: Mihai Mihaescu, Anders Dahikild, Christophe Duwig, Laszlo Fuchs.





CCGEx at the Royal Institute of Technology (KTH) • [www.ccgex.kth.se](http://www.ccgex.kth.se)